

DUOX

FERMAX

KIT VIDEO DUOX MARINE 1-2 L
DUOX VIDEO MARINE KIT 1-2 L
KIT VIDÉO DUOX MARINE 1-2 L
DUOX VIDEO-SET MARINE 1-2 L
KIT VÍDEO DUOX MARINE 1-2 L

GUÍA INICIO RÁPIDA
QUICK START GUIDE
GUIDE DE MISE EN MARCHE RAPIDE
SCHNELLSTARTANLEITUNG
GUIA DE INICIAÇÃO RÁPIDA





INSTALACIÓN

INSTALACIÓN DE LA PLACA EN LA CALLE Y DEL MONITOR

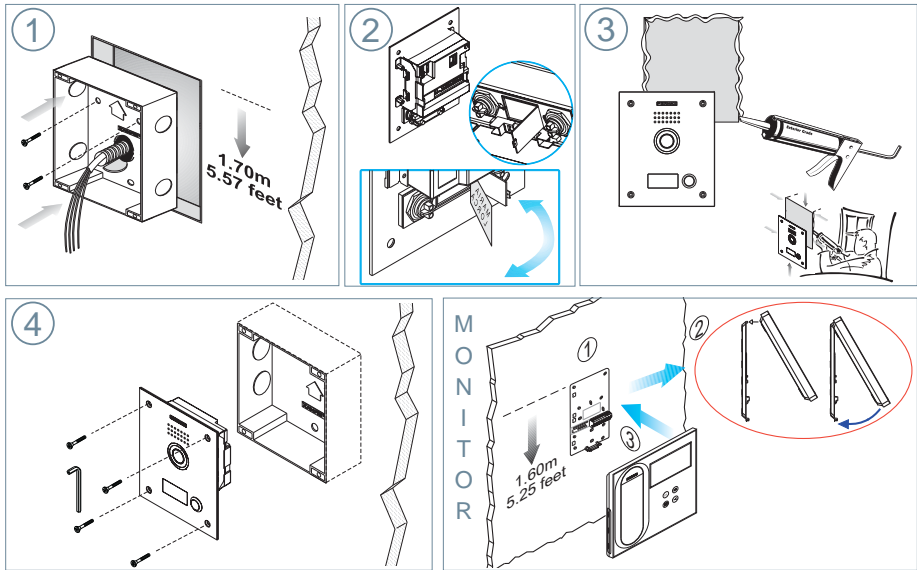

CONFIGURACIÓN





MONITOR VEO DUOX

El monitor suministrado en el kit YA SALE PROGRAMADO de fábrica.

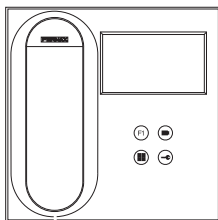
En el caso del kit de 2 líneas ambos monitores SALEN PROGRAMADOS.

BOTONES CONTROL



-  Menú digital para ajustes y configuración de parámetros internos. (Si el monitor está programado).
-  En conversación, pulsar para abrir la puerta.
-  En reposo, llamada al conserje (si existe conserjería).
-  Función auxiliar (consulte con su instalador).
-  En reposo, pulsar y se visualiza en pantalla la posibilidad de realizar autoencendido con diferentes placas. Pulsando secuencialmente Placa 0, Placa 1, Placa General, (según disponibilidad de placas).



El monitor VEO incorpora un menú OSD que se gestiona a través de los pulsadores del monitor para acceder a las funciones de uso y programación del terminal.

Los iconos visualizados en pantalla se manejan con los pulsadores correspondientes ubicados en el monitor.

3. CODIFICAR PLACAS

Siempre que exista más de una placa, será necesario programar el número de placas.
(Para más detalles ver manual placas marine cod. 97899 en www.fermax.es).

4. ENFOQUE DE LA CÁMARA / TIEMPO ACTIVACIÓN DEL ABREPUERTAS

Para ajustar la imagen de la cámara o ajustar el tiempo de activación del abrepuertas, ver Configuración asistida por voz en placas de pulsadores cod. 97765. Instrucción incluida en este equipo.



CARACTERÍSTICAS TÉCNICAS

CARACTERÍSTICAS TÉCNICAS PLACA

Alimentación	18 Vdc
Consumo en reposo	165mA
Consumo audio activo	275 / 480(max) mA
Potencia audio sentido vivienda-calle	1 W
Potencia audio sentido calle-vivienda	0,15 W
Temperatura de funcionamiento	[-25°, +55°C] / [-13°, 131°F]
Volumen regulable en ambos sentidos	

VALORES PLACA

Tiempo activación abrepuertas	01...99 seg. (por defecto: 03)
Tiempo activación botón salida	00...99 seg. (por defecto: 06) / (desactivado: 00)
Tipo de placa	sub-bloque/bloque/entrada general. (por defecto: bloque)
Número de placa	0...9 (por defecto: 00)
Placa MÁSTER no activa	

CARACTERÍSTICAS TÉCNICAS MONITOR (Pantalla OSD TFT 4,3")

Alimentación	18 Vdc
Consumo en reposo	25 mA
Consumo audio + video	230 mA
Temperatura de funcionamiento	[-5°, +40°C] / [23°, 104°F]



ESQUEMAS

TABLA SECCIONES - DISTANCIAS

Tablas secciones distancias - INSTALACIÓN DE KITS de VIDEO con FILTRO (1 y 2 Líneas)				
SECCIÓN CABLE	TERMINALES por vivienda sin fuentes adicionales	 Distancia máxima (A) Fuente/Filtro hasta Placa (Placa-Abrepuertas) (i) Ref. 3244	 Distancia máxima (A) Fuente/Filtro hasta Placa (SIN Abrepuertas) Ref. 3244	 Distancia máxima (B) Fuente/Filtro hasta el Terminal más alejado Ref. 3244
2 x 1 mm ²	1	50m	90m	200m
	2 / 3	30m	70m	50m
2 x 0,5 mm ²	1	20m	60m	100m
	2 / 3	15m	30m	25m
2 x 0,2 mm ²	1	10m	20m	45m
	2 / 3	5m	15m	10m

-(i) Para abrepuertas de 12Vdc y consumo máx. 250mA, alimentador desde el amplificador.

Nota: Para un funcionamiento óptimo, se recomienda utilizar el mismo tipo de cable para toda la instalación.

ESQUEMA CABLEADO KIT 2 LÍNEAS

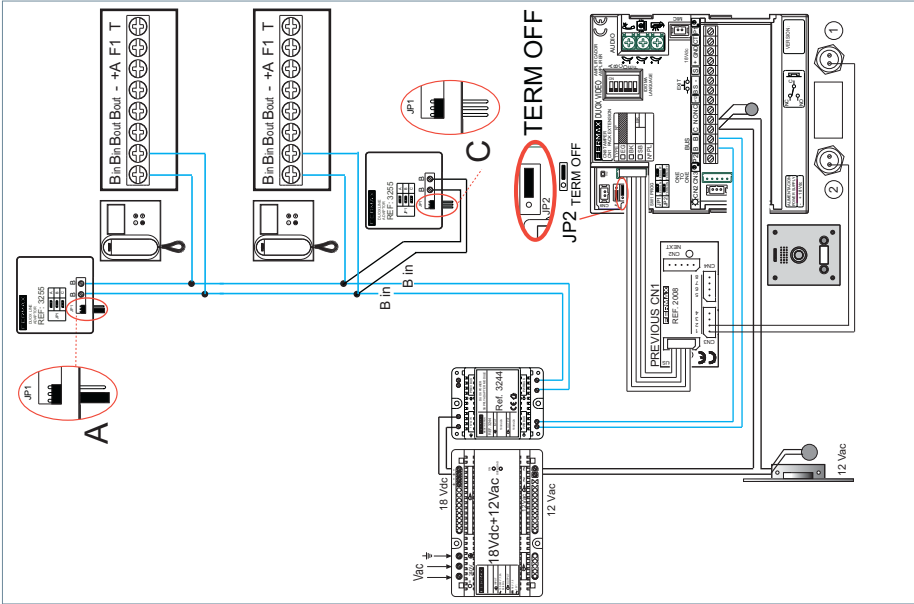

ESQUEMA CABLEADO KIT 1 LÍNEA

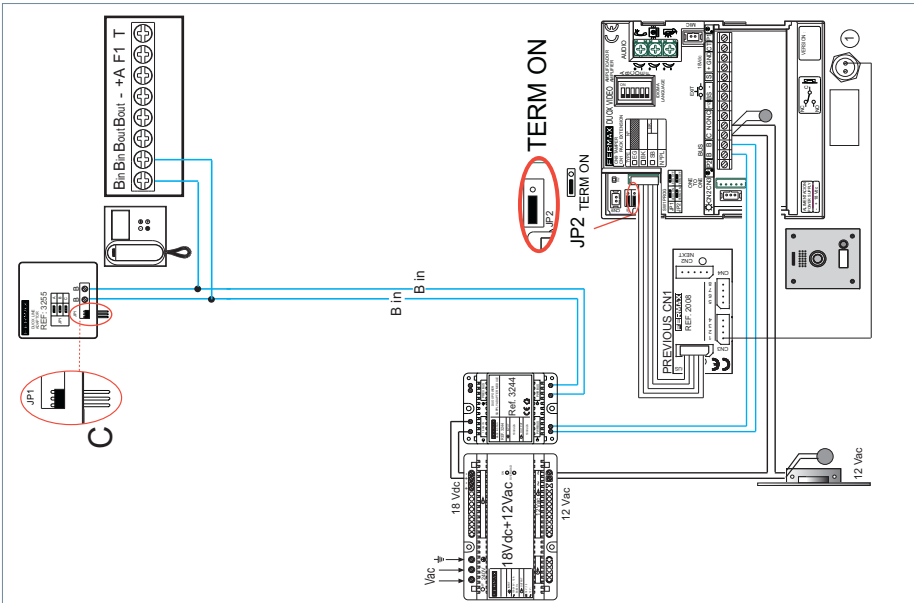

Nota: Este documento muestra los conceptos más básicos para la rápida puesta en marcha, para más información descargar los manuales en www.fermax.com
 - Placas Marine Video Duox cod. 97899.
 - Monitor Duox Veo cod. 97858.



INSTALLATION

INSTALLATION OF STREET PANEL AND MONITOR

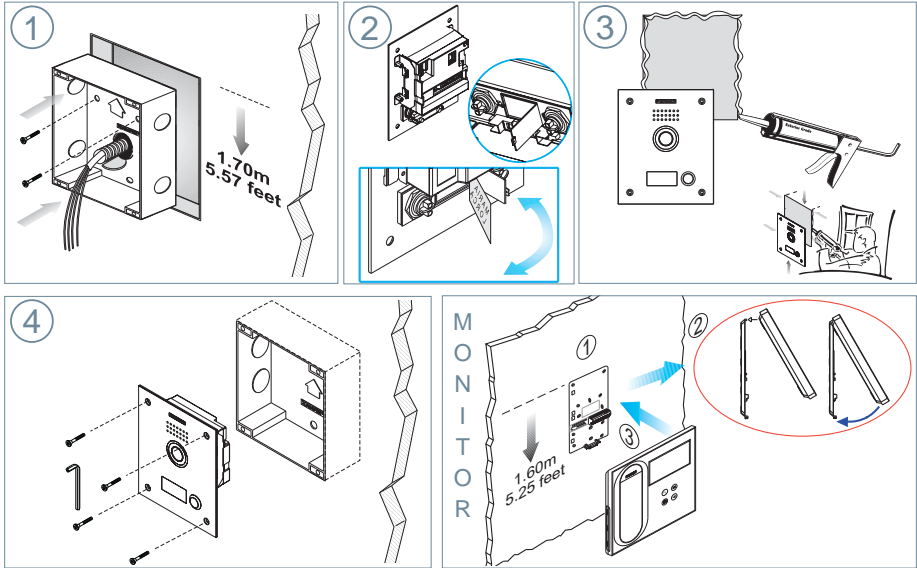

CONFIGURATION

VEO DUOX MONITOR

The monitor supplied in the kit comes **PRE-PROGRAMMED** from the factory.
If the kit has 2 lines, both monitors, they are **PRE-PROGRAMMED**.

CONTROL BUTTONS

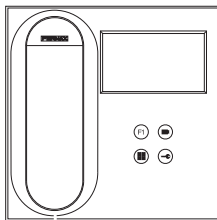

Digital menu for internal parameter settings and configuration. (When the monitor has already been programmed)



In conversation, press to open the door.
In standby, call to guard unit (if applicable).



Auxiliary function, (contact your installer).



In standby, press and it displays the option of auto-starting with different panels. By sequentially pressing Panel 0, Panel 1, General Panel, (depending on the available panels).



VEO monitor incorporates an OSD menu that is managed via the monitor's push buttons to access the terminal's user and programming functions.



The icons displayed are managed with the corresponding buttons located on the monitor.



SETTINGS



1. MONITOR SETTINGS

VIDEO SETTINGS

With an image on the monitor, by pressing the button , (or upon receiving a call without picking up), press the  key to show the **video settings**.

MANUAL
FULL
MONITOR





Select the settings option and increase or decrease with  and .

AUDIO SETTINGS

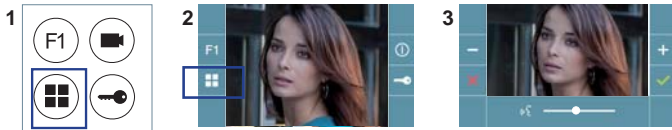
While the audio channel is open, press the  button and a menu screen appears for this setting.



Increase or decrease with  and , until obtaining the desired regulation.

Notice: Maximum conversation time: 90 seconds.

2. PANEL SETTINGS

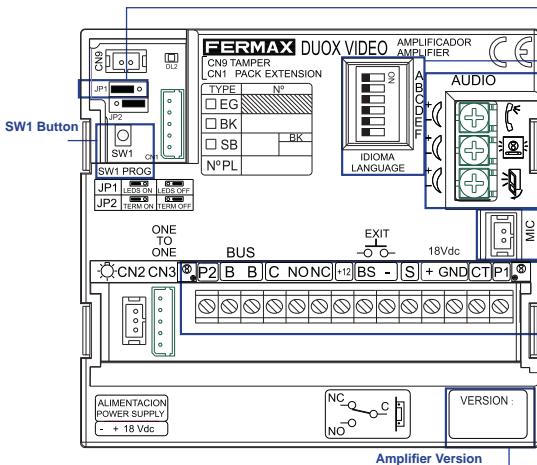

JP1: Camera leds
LEDS ON. On when the camera is activated.
LEDS OFF. always off

Selecting the language¹
of the "door open" message

Audio Settings
of the Monitor, panel and open door.

Microphone Connection

Panel Connectors:
B, B: DUOX Bus: telephone/monitors power, data, audio and video.
C, NO, NC: Relay contacts 2A@30Vdc (lock-release connection).
+12: 12 Vdc-250mA output (maximum 500mA for 100 seconds).
BS, -: entrance hall button.
S, -: door sensor input.
+, GND: not available Future versions.
P1, P2: Button Connection

¹Door open¹ warning language selection

3. ENCODING PANELS

Whenever there is more than one panel, you must program the number of panels. For more details see the marine panel's manual cod. 97899 at www.fermax.es.

4. CAMERA FOCUS / LOCK RELEASE ACTIVATION TIME

To adjust the camera image or adjust the lock-release activation time, see Voice assisted configuration in button panels cod. 97765. Instructions included with this equipment.

TECHNICAL FEATURES

PANEL TECHNICAL CHARACTERISTICS

Power Supply	18 Vdc
Standby Consumption	165mA
Audio active consumption	275 / 480 (max) mA
Audio Power in Residence - Entry Panel Direction	1 W
Audio Power in Entry Panel - Residence Direction	0.15 W
Operating temperature	[-25° , +55°C] / [-13°, 131°F]
Volume can be Regulated in Both Directions.	

PANEL VALUES

Lock-release activation time	01...99 sec. (Default: 03)
Exit button activation time	00...99 sec. (Default: 06) / (deactivated: 00)
Panel type	sub-block/block/general entrance. (Default: block)
Panel number	0..9 (by default: 00)
- MASTER panel: not active.	

MONITOR TECHNICAL CHARACTERISTICS (OSD TFT 4,3" Screen)

Power supply 18 Vdc	
Standby consumption	25 mA
Audio + video consumption	230 mA
Operating temperature	[-5° , +40°C] / [23°, 104°F]

FLOOR SECTIONS-DISTANCES TABLE

Distance section table - VIDEO KIT INSTALLATION WITH FILTER (1 AND 2 LINES)				
SECTION CABLE		 Maximum distance (A) Source/Filter up to Panel (Panel-Lock release) (i)	 Maximum distance (A) Source/Filter up to Panel (WITHOUT lock release)	 Maximum distance (B) Source/Filter up to Panel Furthest terminal
2 x 1 mm ²	1	50m	90m	200m
	2 / 3	30m	70m	50m
2 x 0,5 mm ²	1	20m	60m	100m
	2 / 3	15m	30m	25m
2 x 0,2 mm ²	1	10m	20m	45m
	2 / 3	5m	15m	10m

- (i) For the 12Vdc lock-release and max. consumption 250mA, powered by the amplifier.

Notice: For optimal performance, we recommend using the same type of cable throughout the installation.

2 LINES WIRING DIAGRAM KIT

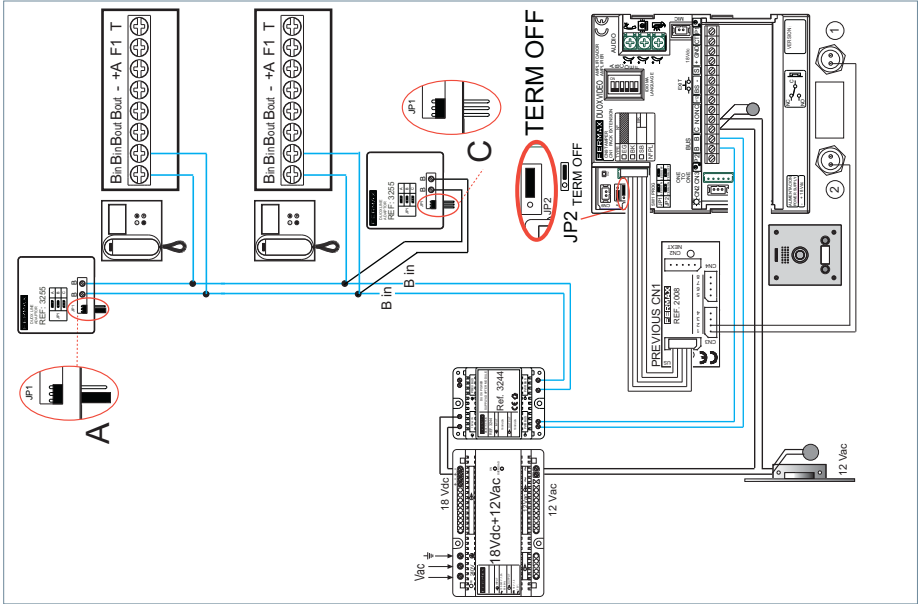

1 LINES WIRING DIAGRAM KIT

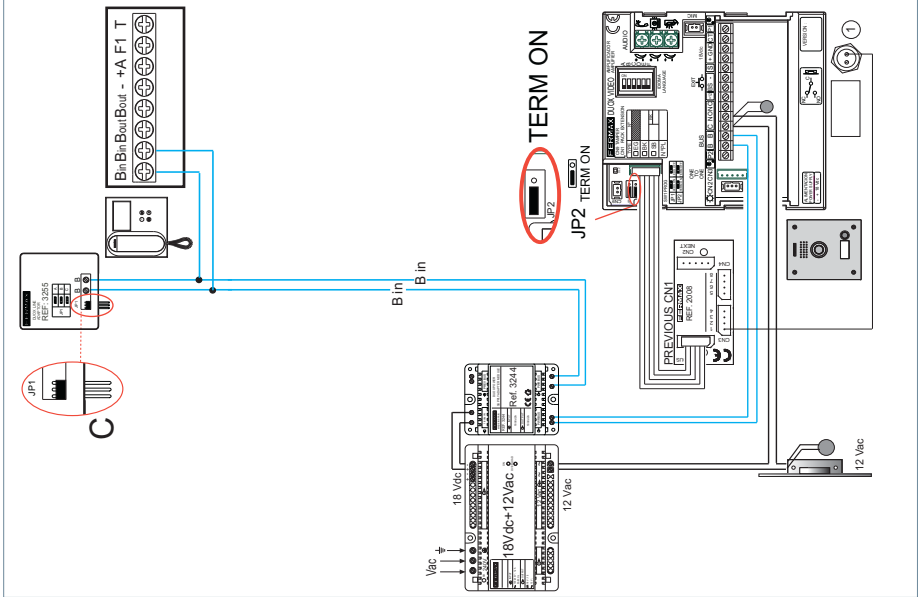

Notice: This document shows the basic concepts for a quick start-up. For more information download the manuals at www.fermax.com

- Marine Video Duox Panels cod. 97899.
- Monitor Duox Veo cod. 97858.

INSTALLATION

INSTALLATION DE LA PLATINE CÔTÉ RUE ET DU MONITEUR

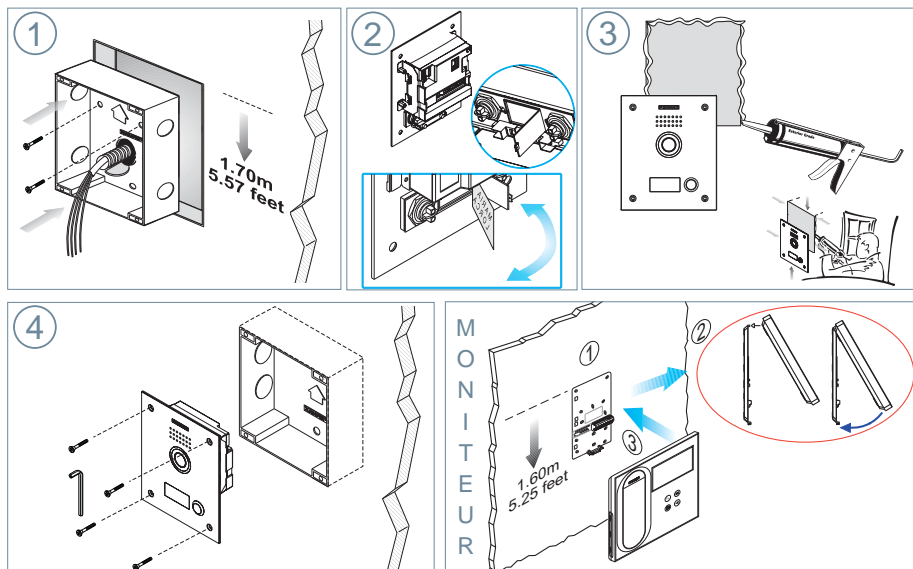

CONFIGURATION





MONITEUR VEO DUOX

Le moniteur fourni dans le kit EST DÉJÀ PROGRAMMÉ par défaut.

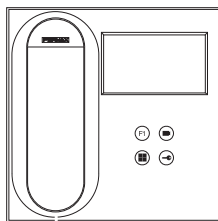
Dans le cas des kits à 2 lignes, les deux moniteurs SONT PROGRAMMÉS.

BOUTONS DE COMMANDE



-  Menu numérique pour les réglages et configuration des paramètres internes (si le moniteur est programmé).
-  Lors d'une communication, appuyez dessus pour ouvrir la porte.
En veille, appel au concierge (s'il y a un conciergerie).
-  Fonction auxiliaire (contactez votre installateur).
En veille, appuyez dessus. On a, à l'écran, la possibilité d'effectuer
-  l'auto-insertion avec différentes platines. En appuyant de manière séquentielle sur la platine 0, platine 1, platine générale (selon la disponibilité des platines).



Le moniteur VEO intègre un menu OSD qui est géré à l'aide des boutons-poussoirs du moniteur afin d'accéder aux fonctions d'utilisation et de programmation du terminal. Les icônes qui apparaissent à l'écran se manipulent à l'aide des boutons-poussoirs correspondants du moniteur.



RÉGLAGES

1. RÉGLAGES DU MONITEUR

MANUEL
COMPLET
MONITEUR

RÉGLAGES VIDÉO

Si on a de l'image sur le moniteur en appuyant sur le bouton (ou lors de la réception d'un appel sans décrocher), appuyez sur la touche pour afficher les **réglages vidéo**.



Sélectionnez l'option de réglage et augmentez ou diminuez à l'aide de et .

RÉGLAGES AUDIO

Pendant que le canal audio est ouvert, appuyez sur le bouton et le menu pour ce réglage apparaîtra à l'écran.

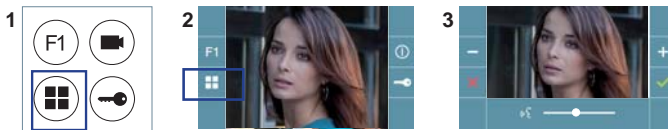

Augmentez ou diminuez à l'aide de et jusqu'à obtenir le réglage souhaité.

Remarque : temps maximal de communication : 90 secondes.

2. RÉGLAGES PLATINES

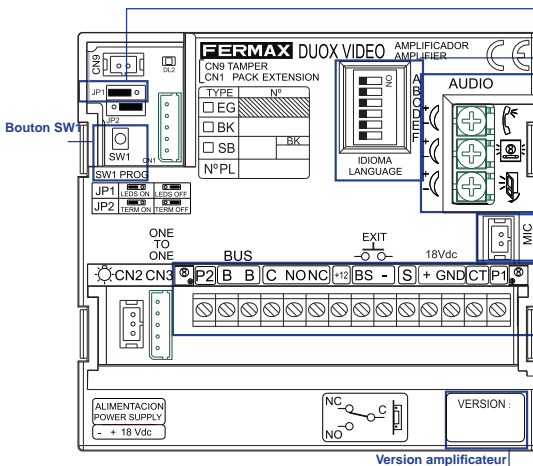

JP1 : DEL caméra

DEL ON. Activées si la caméra est activée.
DEL OFF. Toujours éteintes.

Sélection de la langue¹
du message « porte ouverte »

Réglages son

du moniteur, de la platine et de la porte ouverte.

Raccordement microphone

Connecteurs platine :

B, B : bus DUOX : alimentation postes/moniteurs, données, audio et vidéo.
C, NO, NC : contacts relais, 2 A @ 30 Vcc (connexion gâche électrique).
+12 : sortie 12 Vcc-250 mA (500 mA maximum pendant 100 s).
BS, - : bouton-poussoir hall.
S, - : entrée capteur de porte.
+, **GND** : non disponible. Futures versions.
P1, P2 : connexion boutons-poussoirs.

¹ Sélection de la langue du message vocal émis pour « porte ouverte ».

0 Espagnol	1 Anglais	2 Français	3 Néerlandais/Flamand	4 Allemand	5 Catalan	6 Valencien	7 Baléare	8 Portugais	9 Basque	10 Galicien
11 Grec	12 Polonais	13 Tchèque	14 Slovaque	15 Turc	16 Chinois	17 Persan/Farsi	18 Arabe	19 Norvégie	20 Finnois	21 Suédois
22 Danois	23 Islandais	24 Russe	25 Italien	26 Hindi	27 Hongrois	28 Hébreux	29 Croate	30...62 Cloche	62 cloche	63 DÉACTIVÉ

3. CODIFICATION DES PLATINES

Il faut, dès qu'il y a plus d'une platine, programmer le numéro des platines (pour plus de renseignements, voir le manuel des platines Marine code 97899 sur www.fermax.com).

4. FOCALISATION DE LA CAMÉRA / TEMPS D'ACTIVATION DE LA GÂCHE ÉLECTRIQUE

Afin de régler l'image de la caméra ou régler le temps d'activation de la gâche électrique, voir Configuration avec assistance vocale sur les platines à boutons-poussoirs code 97765. Instructions fournies avec ce matériel.

CARACTÉRISTIQUES TECHNIQUES

CARACTÉRISTIQUES TECHNIQUES PLATINE

Alimentation	18 Vcc
Consommation en veille	165 mA
Consommation avec son	275 / 480 (max) mA
Puissance du son sens logement-rue	1 W
Puissance du son sens rue-logement	0,15 W
Température de service	[-25 , +55 °C] / [-13, 131 °F]
Volume réglable dans les deux sens	

VALEURS PLATINE

Durée activation de la gâche	01...99 s. (par défaut : 03)
Durée activation bouton de sortie	00...99 s. (par défaut : 06) / (désactivé : 00)
Type de platine	sous-bâtiment/bâtiment/entrée générale. (par défaut : bâtiment)
Numéro de platine	0...9 (par défaut : 00)
Platine MASTER non active	

CARACTÉRISTIQUES TECHNIQUES MONITEUR (écran OSD TFT 4,3")

Alimentation	18 Vcc
Consommation en veille	25 mA
Consommation son + image	230 mA
Température de service	[-5, +40 °C] / [23, 104 °F]

SCHÉMAS

TABLEAU SECTIONS - DISTANCES

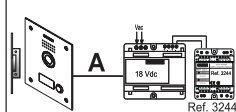
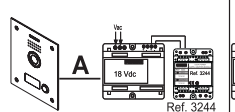
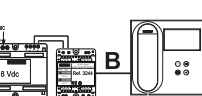
Tableaux sections distances - INSTALLATION DE KITS VIDÉO avec FILTRE (1 et 2 lignes)				
SECTION CÂBLE				
	TERMINAUX pour logement sans alimentations supplémentaires	Distance maximale (A) Alimentation/filtre jusqu'à la platine (platine-gâche électrique) (1)	Distance maximale (A) Alimentation/filtre jusqu'à la platine (SANS gâche électrique)	Distance maximale (B) Alimentation/filtre jusqu'au terminal le plus éloigné
2 x 1 mm ²	1	50m	90m	200m
	2 / 3	30m	70m	50m
2 x 0,5 mm ²	1	20m	60m	100m
	2 / 3	15m	30m	25m
2 x 0,2 mm ²	1	10m	20m	45m
	2 / 3	5m	15m	10m

- (1) Pour une gâche de 12 Vcc avec une consommation max. de 250 mA, alimentation depuis l'amplificateur.

Remarque : pour un fonctionnement optimal, il est recommandé d'utiliser le même type de câble pour toute l'installation.

SCHÉMA DE CÂBLAGE KIT 2 LIGNES



SCHÉMA DE CÂBLAGE KIT 1 LIGNE



Remarque : ce document présente les concepts les plus basiques, qui permettent une mise en marche rapide. Pour plus de renseignements, téléchargez les manuels sur www.fermax.com

- Platinos vidéo Marine Duox code 97899.
- Moniteur Duox Véo code 97858.

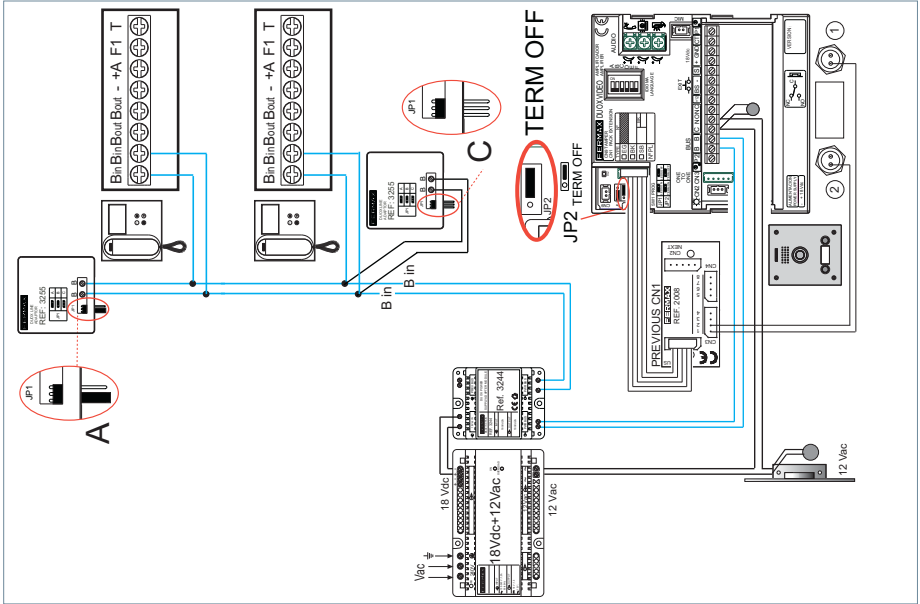
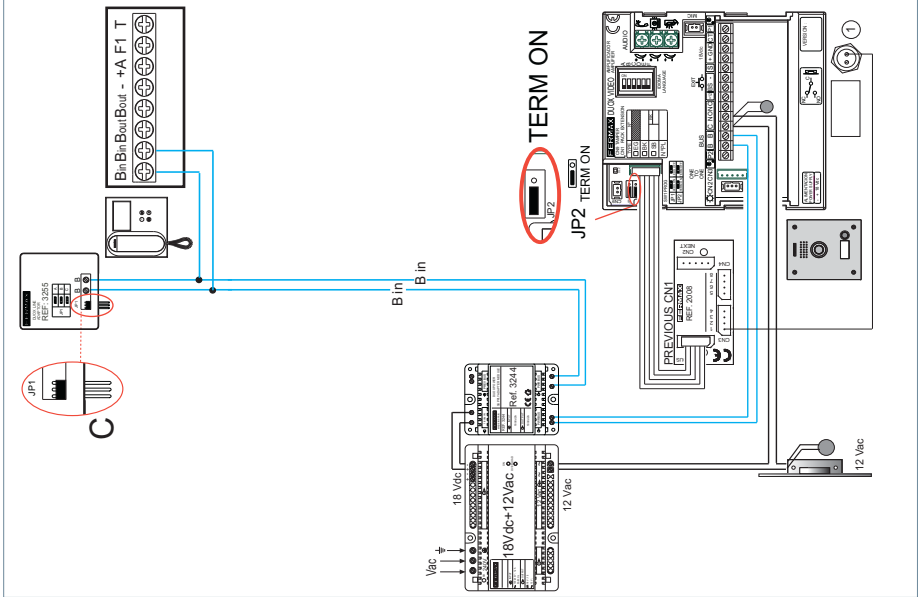
✂ INSTALLATION

TÜRSTATION- UND MONITORINSTALLATION

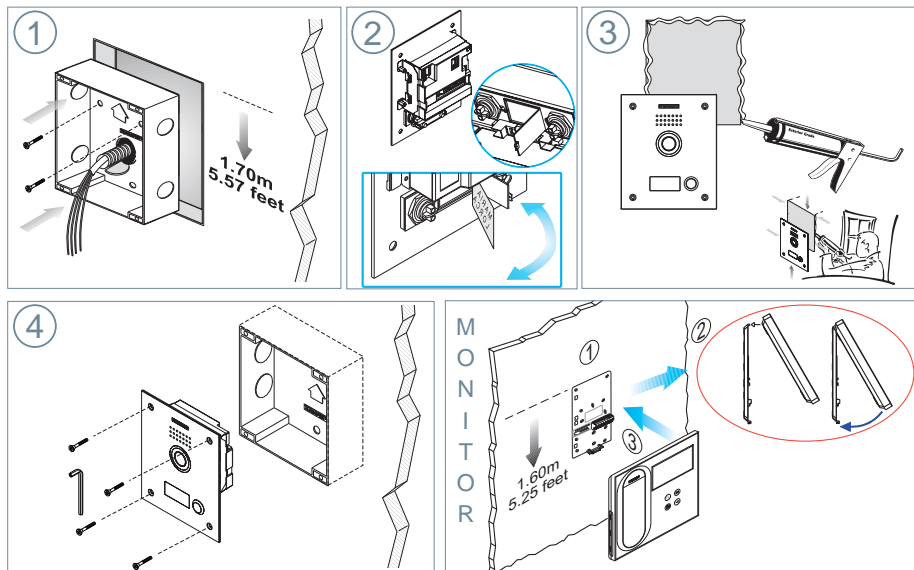

🖥 KONFIGURATION

MONITOR DUOX VEO

Der im Set mitgelieferte Monitor ist **BEREITS WERKSSEITIG** programmiert!
Beim Set mit 2 Linien sind die Monitore auch **VORPROGRAMMIERT**.

BEDIENTASTEN

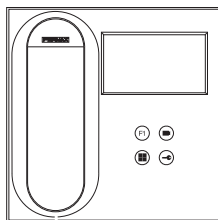

- 🖥 Digitales Menü zur Vornahme der Einstellung und Konfiguration der internen Parameter. (Falls der Monitor programmiert ist.)
- 🔑 Im Sprechmodus drücken, um die Tür zu öffnen. Im Bereitschaftsmodus kann der Portier angerufen werden (falls eine Portierzentrale vorhanden ist).
- F1 Zusatzfunktion (fragen Sie den Installateur).
- 🔊 Im Bereitschaftsmodus drücken, um auf dem Bildschirm die Eigenstartoption der jeweiligen Türstationen einzublenden. Dazu abwechselnd Türstation 0, Türstation 1 und Haupttürstation (gemäß Verfügbarkeit der Türstationen) drücken.

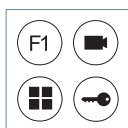

Der Monitor enthält ein OSD-Menü, das über die Monitortasten bedient werden kann, um die Betriebs- und Programmierfunktionen der Sprechstelle aufzurufen. Die auf dem Bildschirm angezeigten Symbole werden mit den entsprechenden Monitortasten bedient.



EINSTELLUNGEN

HANDBUCH
KOMPLETT
MONITOR



1. MONITOREINSTELLUNGEN

VIDEOEINSTELLUNGEN

Wenn ein Bild auf dem Monitor eingeblendet wird (oder bei einem eingehenden Anruf ohne abzuhängen) zuerst die Taste und anschließend die Taste drücken, um die **Videoeinstellungen** einzublenden.



Die gewünschte Option auswählen und die Einstellungen mit den Tasten und erhöhen oder verringern.

AUDIOEINSTELLUNGEN

Während der Audiokanal geöffnet ist, die Taste drücken, um die Menüfunktionen dieser Einstellung aufzurufen.

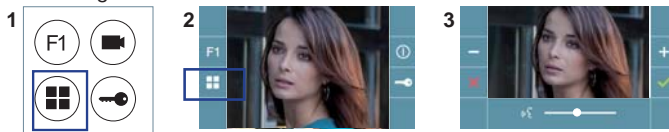

Mithilfe der Tasten und können die Einstellungen entsprechend angepasst werden.

Hinweis: Maximale Gesprächsdauer: 90 Sekunden

2. TÜRSTATIONEINSTELLUNGEN

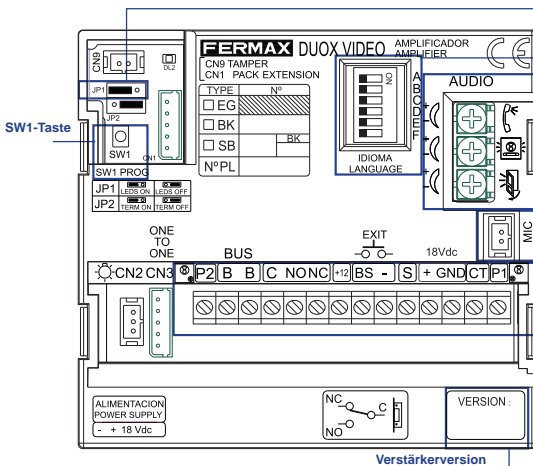

JP1: Kamera-LEDs
LEDS EIN, wenn die Kamera aktiviert ist.
LEDS AUS, immer ausgeschaltet.

Sprachwahl ¹
der Meldung "Tür offen".

Audioeinstellungen
des Monitors, der Türstation und Meldung Tür öffnen.

Mikrofonanschluss

Anschlüsse Türstation:

- B, B:** DUOX-Bus: Stromversorgung Telefone/Monitore, Daten, Audio und Video.
- C, NO, NC:** Relais-Kontakte, 2A@30VDC (Anschluss Türöffner).
- +12:** Ausgang (12 VDC/250 mA) (max. 500mA während 100 Sek.).
- BS, -:** Türöffnungstaste Flur.
- S, -:** Türsensor Eingang.
- +, GND:** nicht verfügbar. Zukünftige Versionen.
- P1, P2:** Tastenanschluss.

¹ Sprachwahl der Meldung „Tür offen“

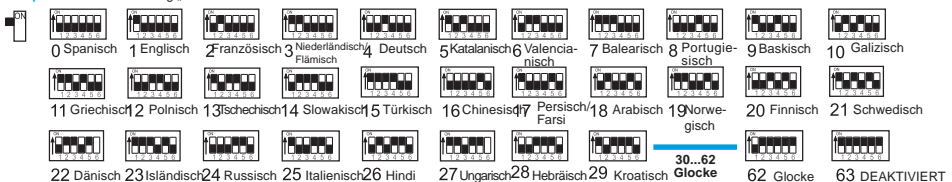

3. TÜRSTATIONEN KONFIGURIEREN

Falls mehr als eine Türstation vorhanden ist, müssen die Türstationen programmiert werden, damit sie Nummern aufweisen. (Für weitere Information siehe Handbücher Türstationen Marine, Kode 97899 auf www.fermax.es).

4. KAMERAFAKUS / AKTIVIERUNGSZEIT DES TÜRÖFFNERS

Um das Kamerabild oder die Aktivierungszeit des Türöffners einzustellen, siehe sprachgeführte Konfiguration bei Türstationen mit Tastenmodulen, Kode 97765. Die Anleitung ist in der Geräteverpackung enthalten.



TECHNISCHE EIGENSCHAFTEN

TECHNISCHE EIGENSCHAFTEN TÜRSTATION

Stromversorgung	18 VDC
Stromverbrauch im Bereitschaftsmodus	165 mA
Stromverbrauch im Sprechmodus	275 / 480 (max) mA
Audialeistung Wohnung ->Türstation	1 W
Audialeistung Türstation > Wohnung	0,15 W
Betriebstemperatur	[- 25 °C , + 55 °C] / [- 13 °F, 131 °F]
Regulierbare Lautstärke in beiden Richtungen	

WERTE TÜRSTATION

Aktivierungszeit Türöffner	01...99 Sek. (standardmäßig: 03)
Aktivierungszeit Türöffnungstaste:	00...99 Sek. (standardmäßig: 06) / (deaktiviert: 00)
Türstationtyp	Nebenblock/Block/Haupteingang, (standardmäßig: Block)
Türstationnummer	0...9 (standardmäßig: 00)

MASTER-Türstation ist nicht aktiviert

TECHNISCHE EIGENSCHAFTEN MONITOR (4,3" Flachbildschirm mit Bildschirmanzeige (OSD))

Stromversorgung	18 VDC
Stromverbrauch im Bereitschaftsmodus	25 mA
Stromverbrauch Audio + Video	230 mA
Betriebstemperatur	[- 5 °C , + 40 °C] / [23 °F, 104 °F]



SCHEMATA

QUERSCHNITT-UNDABSTANDSTABELLE

Querschnitt- und Abstandstabellen - INSTALLATION VON VIDEO-SETS MIT FILTER (1 und 2 Linien)

KABEL QUERSCHNITT	SPRECHSTELLEN pro Wohnung ohne zusätzliche Netzgeräte	Maximaldistanz (A) Netzgerät/Filter bis Türstation (Türstation-Türöffner) (i)		Maximaldistanz (A) Netzgerät/Filter bis Türstation (OHNE Türöffner)		Maximaldistanz (B) Netzgerät/Filter bis zur am weitesten entfernte Sprechstelle	
		1	2 / 3	1	2 / 3	1	2 / 3
2 x 1 mm ²	1	50m	30m	90m	70m	200m	50m
	2 / 3						
2 x 0,5 mm ²	1	20m	15m	60m	30m	100m	25m
	2 / 3						
2 x 0,2 mm ²	1	10m	5m	20m	15m	45m	10m
	2 / 3						

(i) Für 12-VDC-Türöffner und maximalem Stromverbrauch von 250 mA, mit Stromversorgung über den Verstärker.

Hinweis: Für einen optimalen Betrieb empfehlen wir denselben Kabeltyp für die gesamte Anlage zu verwenden.

VERKABELUNGSSCHEMA 2-LINIEN-SET

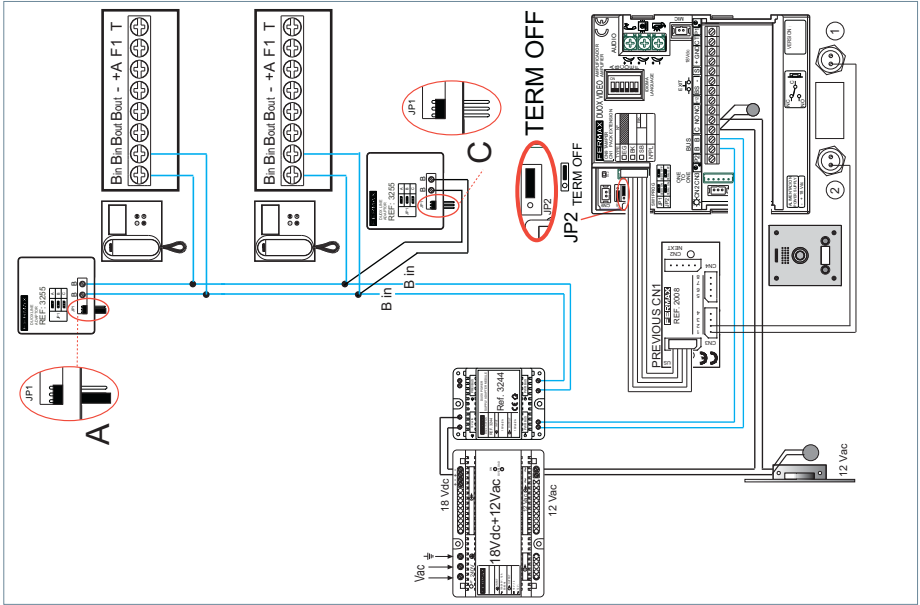

VERKABELUNGSSCHEMA 1-LINIEN-SET

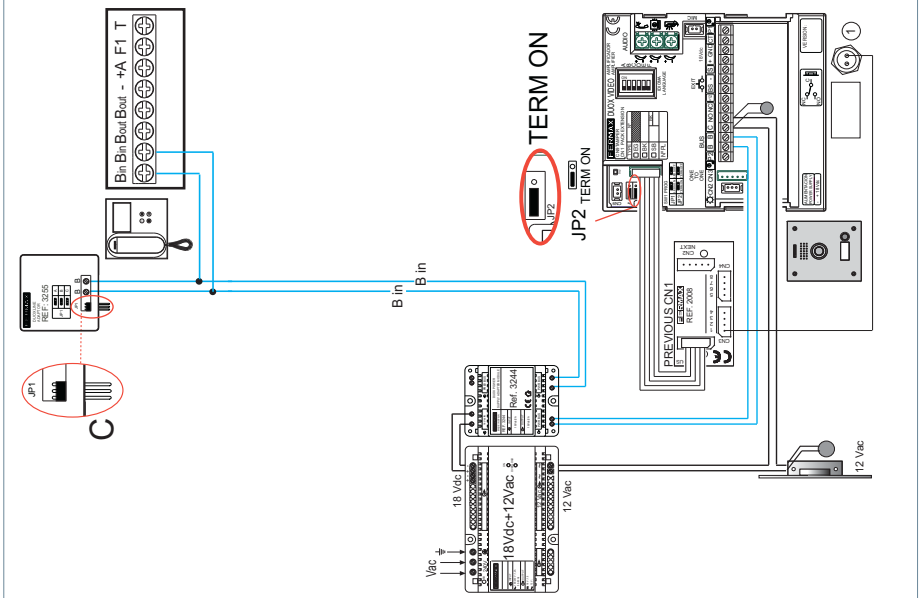

Hinweis: Dieses Dokument veranschaulicht die grundlegenden Konzepte für eine schnelle Inbetriebnahme der Anlage. Weitere Information können Sie den Handbüchern auf www.fermax.com entnehmen.

- Türstationen Marine Video Duox, Kode 97899.
- Monitor Duox Veo, Kode 97858.



INSTALAÇÃO

INSTALAÇÃO DA BOTONEIRA NA RUA E DO MONITOR

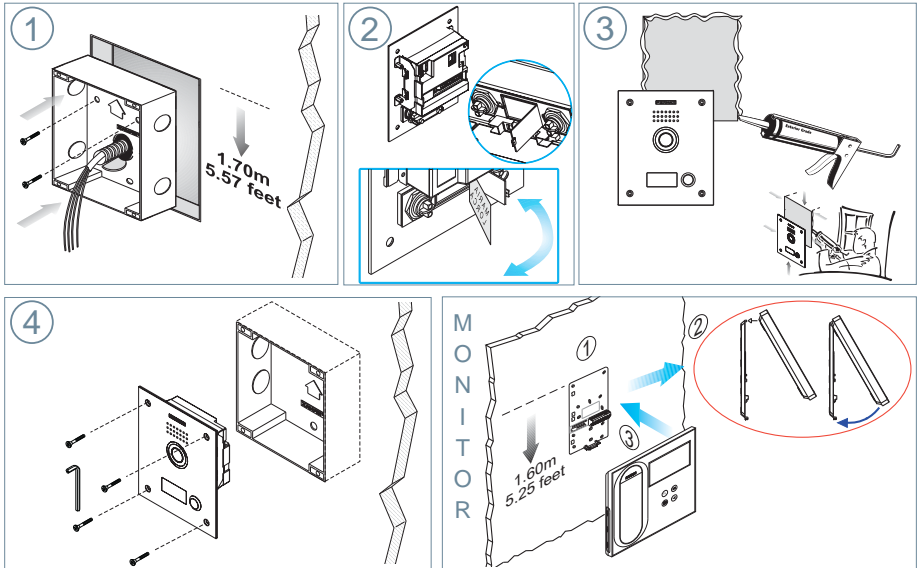

CONFIGURAÇÃO

MONITOR VEO DUOX

O monitor fornecido no kit **JÁ VEM PROGRAMADO** de fábrica!

No caso do kit de 2 linhas, ambos os monitores já **VÊM PROGRAMADOS**.

BOTÕES DE CONTROLO

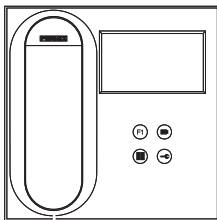

- Menu digital para ajustes e configuração de parâmetros internos (se o monitor está programado).
- Em conversação, premir para abrir a porta.
- Em repouso, chamada ao porteiro (se existir portaria).
- Função auxiliar (consulte o seu instalador).
Em repouso, ao premir, visualiza-se no ecrã a possibilidade de efetuar a ligação automática com diferentes botoneiras. Premindo sequencialmente Botoneira 0, Botoneira 1, Botoneira Geral (conforme a disponibilidade de botoneiras).

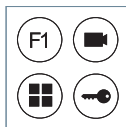

O monitor VEO integra um menu OSD que é gerido através dos botões do monitor para aceder às funções de utilização e programação do terminal.

Os ícones visualizados no ecrã são comandados por meio dos botões correspondentes localizados no monitor.



AJUSTES

1. AJUSTES DO MONITOR

AJUSTES DE VÍDEO

Tendo imagem no monitor ao premir o botão , (ou ao receber uma chamada sem atender) pressionar a tecla para mostrar os **ajustes de vídeo**.

MANUAL
COMPLETO
MONITOR



Selecionar a opção do ajuste e ir aumentando ou diminuindo com e .

AJUSTES DE ÁUDIO

Enquanto o canal de áudio estiver aberto, premindo o botão , aparecerá no ecrã o menu para tal ajuste.

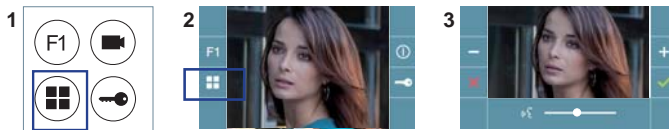

Ir aumentando ou diminuindo com e , até obter a regulação desejada.

Nota: Tempo máximo de conversação: 90 segundos.

2. AJUSTES DAS BOTONEIRAS

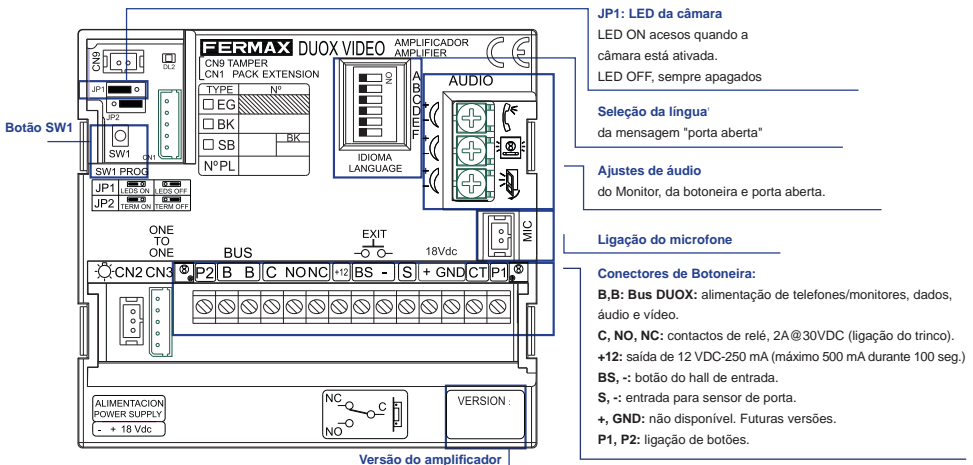

1 Seleção da língua da mensagem "Porta aberta"



3. CODIFICAR BOTONEIRAS

Sempre que exista mais que uma botoneira, será necessário programar o número de botoneiras. (Para mais detalhes, ver o Manual de placas Marine cód. 97899 em www.fermax.es).

4. FOCAGEM DA CÂMARA / TEMPO DE ATIVAÇÃO DO TRINCO

Para ajustar a imagem da câmara ou regular o tempo de ativação do trinco, ver Configuração assistida por voz em placas de interruptores cód. 97765. Instrução incluída neste equipamento.

CARACTERÍSTICAS TÉCNICAS

CARACTERÍSTICAS TÉCNICAS DA BOTONEIRA

Alimentação	18 Vdc
Consumo em repouso	165 mA
Consumo de áudio ativo	275 / 480 (max) mA
Potência de áudio no sentido habitação-rua	1 W
Potência de áudio no sentido rua-habitação	0,15 W
Temperatura de funcionamento	[-25°, +55°C] / [-13°, 131°F]
Volume regulável em ambos os sentidos	

VALORES DA BOTONEIRA



Tempo de ativação do trinco	01...99 seg. (por predefinição: 03)
Tempo de ativação do botão de saída	00...99 seg. (por predefinição: 06) / (desativado: 00)
Tipo de botoneira	subbloco/bloco/entrada geral. (por predefinição: bloco)
Número de botoneira	0...9 (por predefinição: 00)
Botoneira MASTER não ativa	

CARACTERÍSTICAS TÉCNICAS DO MONITOR (Ecrã OSD TFT 4,3")

Alimentação	18 VDC
Consumo em repouso	25 mA
Consumo de áudio + vídeo	230 mA
Temperatura de funcionamento	[-5 °, +40 °C] / [23 °, 104 °F]

ESQUEMAS

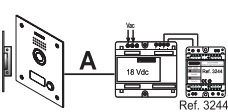
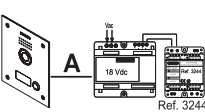
TABELA DE SECÇÕES - DISTÂNCIAS

Tabelas de secções e distâncias - INSTALAÇÃO DE KITS DE VÍDEO com FILTRO (1 e 2 linhas)					
SECÇÃO CABO					Distância máxima (B) Fonte/Filtro até ao Terminal mais afastado
2 x 1 mm ²	1	50m	90m		200m
	2 / 3	30m	70m		50m
2 x 0,5 mm ²	1	20m	60m		100m
	2 / 3	15m	30m		25m
2 x 0,2 mm ²	1	10m	20m		45m
	2 / 3	5m	15m		10m

- (i) Para trincos de 12 VDC e consumo máx. de 250 mA, alimentador a partir do amplificador.

Nota: Para um funcionamento ideal, recomenda-se a utilização do mesmo tipo de cabo em toda a instalação.

ESQUEMA DE CABLAGEM DO KIT DE 2 LINHAS

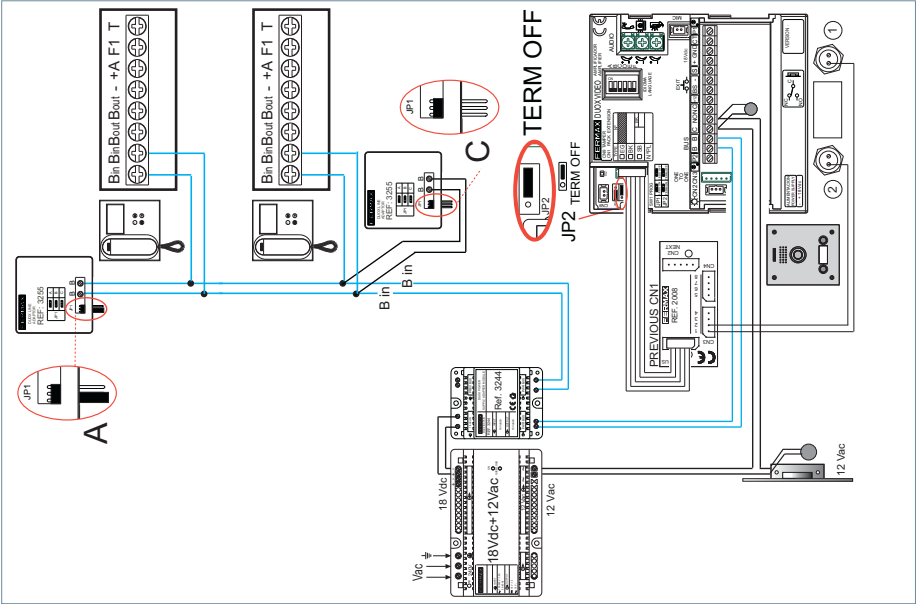

ESQUEMA DE CABLAGEM DO KIT DE 1 LINHA

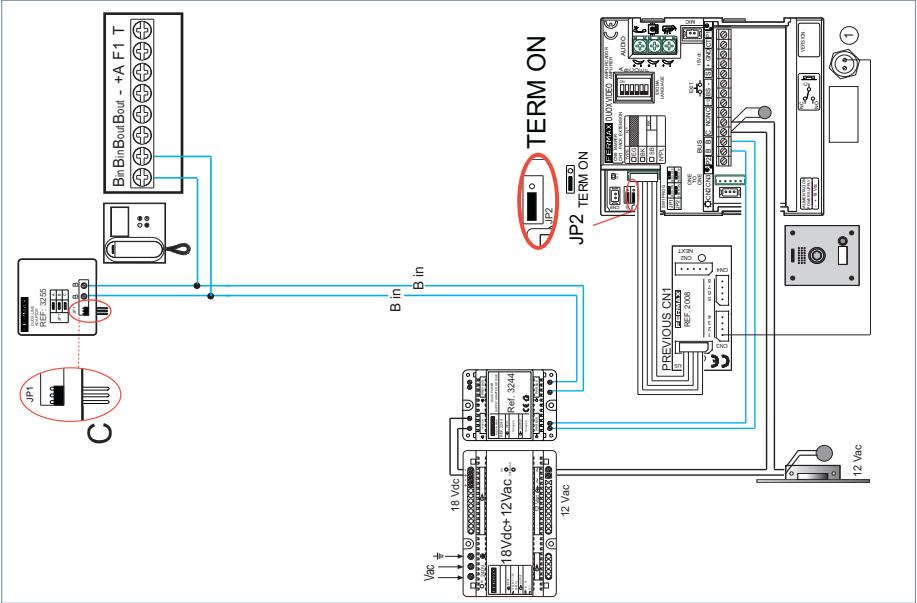

Nota: Este documento apresenta os conceitos mais básicos para a rápida colocação em funcionamento; para mais informação, fazer o download dos manuais em www.fermax.com

- Botoneiras Marine Vídeo Duox cód. 97899.

- Monitor Duox Veo cód. 97858.